

Energy-economic assessment of reduced district heating system temperatures



Roman Geyer ^{a, b, *}, Jürgen Krail ^b, Benedikt Leitner ^a, Ralf-Roman Schmidt ^a, Paolo Leoni ^a

^a AIT Austrian Institute of Technology GmbH, Center for Energy, Integrated Energy Systems, Giefinggasse 6, 1210, Vienna, Austria

^b University of Applied Sciences Burgenland, Department Energy and Environmental Management, Steinamangerstrasse 21, 7423, Pinkafeld, Austria

ARTICLE INFO

Article history:

Received 4 December 2020

Received in revised form

22 February 2021

Accepted 5 March 2021

Available online 16 March 2021

Keywords:

Low temperature

Energy-economic motivation

Monetary benefits

Cost reduction gradient

Competitive district heating networks

ABSTRACT

It is in the DNA of district heating (DH) systems that low temperatures are crucial for efficiency, guaranteeing cost competitiveness and integrating alternative heat sources. The general conviction within the DH community is, that reduced temperatures have positive effects for the whole system and economic benefits can be expected. However, there is a lack in evidence-based data to evaluate these effects in monetary terms. The innovative approach of this work is to analyze key characteristics for different technologies by means of energy-economic assessments to show evidence-based energy-related and monetary benefits of reduced system temperatures. The proven benefits should increase the motivation and conviction of utilities and customers in low-temperature systems, both for reducing system temperatures in existing networks and for new networks. The key indicator cost reduction gradient (CRG), introduced in previous work, was applied for the energy-economic assessment of reduced system temperatures. In total, investigations of nine heat generation technologies, the DH network itself and four storage types are presented. The CRGs for the heat generation technologies varies from 0.08 to 0.67 €/ (MWh · °C). In the case of alternative heat generation technologies such as heat pumps and solar thermal, a higher sensitivity of the monetary effects compared to traditional heat generation technologies can be observed. Here, higher economic benefits and monetary savings can be expected in future DH networks.

© 2021 The Author(s). Published by Elsevier Ltd. This is an open access article under the CC BY license (<http://creativecommons.org/licenses/by/4.0/>).

1. Introduction

District heating (DH) is at a crossroads: Existing systems must be transformed to a cost-effective and, compared to individual heat supply, decarbonized alternative heat supply. Main challenges for DH networks are the increased integration of alternative energy sources (including solar- and geothermal energy, waste heat from the service and industry sector as well as ambient heat via heat pumps) and the development of new business models, involving the end users. The integration of decentralized heat sources faces two major obstacles: Seasonal mismatch and a mismatch of the temperature levels of the supply and demand [1,2]. This paper addresses the latter challenge, as a significant reduction of temperature levels in DH networks is one of the biggest challenges for establishing sustainable energy systems.

* Corresponding author. AIT Austrian Institute of Technology GmbH, Center for Energy, Integrated Energy Systems, Giefinggasse 6, 1210, Vienna, Austria.

E-mail address: roman.geyer@ait.ac.at (R. Geyer).

1.1. Major challenges

According to estimations, about 6000 DH systems in Europe and about 80 000 worldwide exists [3,4]. Especially in urban areas DH systems offer potential for conserving resources [5]. Regarding primary energy savings, further expansion of the DH networks is therefore sensible from a climate and energy policy point of view [1,6]. Despite the constant expansion of the DH networks in Europe and worldwide, their economic efficiency has in some cases been significantly reduced in recent years and their role in decarbonizing the global energy systems must be reinforced. DH systems are facing challenges like [1,2]:

- decreasing specific heat requirements of new buildings,
- low efficiency of existing customer heating systems,
- competition with individual heat supply systems, especially decentralized air heat pumps,
- increasing competition for biomass as well as the trend of phasing out combustion processes for pure heating purposes and

Nomenclature explanation

①	Reference case with typical prevailing temperatures	FGC	Flue gas condensation
②	Assessment case with reduced temperatures	FOM	Fixed operational and maintenance costs
ATES	Aquifer thermal energy storage	FPC	Flat plate collector
BPT	Back-pressure turbine	HP	Heat pump
BTES	Borehole thermal energy storage	Hp-FPC	High-performance flat plate collector
CAPEX	Capital expenditures	IAPWS	International Association for the Properties of Water and Steam
CHP	Combined heat and power	LCOH	Levelized cost of heat
COP	Coefficient of performance	OPEX	Operating expenses
CRG	Cost reduction gradient (key indicator used in this paper in $\text{€}/(\text{MWh}\cdot\text{°C})$)	PTES	Pit thermal energy storage
DH	District heating	Ta	Ambient temperature
ECT	Extraction-condensing turbine	Tm	Mean temperature of solar collector fluid
ETC-CPC	Evacuated tube collector with compound parabolic concentrators	TTES	Tank thermal energy storage
		VOM	Variable operation and maintenance costs

- volatile price developments of (fossil) energy sources, combined with the complexity of (future) European energy markets, including by trend increasing electricity supply from renewables and thus changing role of combined heat and power (CHP) plants.

One of the major decarbonization measures in DH networks is the use of alternative energy sources, e.g., solar- and geothermal energy, waste heat from the service and industry sector or ambient heat via heat pumps. However, those sources are often small-scale and decentralized and/or have a low temperature level, which makes their integration difficult. Especially in large (urban) DH networks, the supply temperatures are usually higher than the efficiently useable temperature level of alternative heat sources [2]. Due to the required installation of heat pumps and the related investments, together with low coefficient of performance (COP) due to high temperature differences, the exploitation of these heat sources is often not reasonable [7].

1.2. Low-temperatures: Driver for decarbonized district heating networks

Low supply and return temperatures are the most important enabler for the integration of alternative heat sources, which are mainly available at low temperature levels or whose full potential can only be realized at low temperature levels [1,8]. Beside better integration of alternative heat sources, low temperatures enable higher efficiency and economy [2]. Further benefits are lower heat distribution losses and pumping power costs. Likewise, more cost-effective piping solutions can be used, and new customers can be connected in areas with network capacity limitations.

However, the current DH networks are often dominated by high temperature heat supply systems. In these systems, low (er) system temperatures make no or only a negligible contribution to increasing their efficiency, the motivation to reduce the temperature level in the existing DH system is low. Due to not obvious economic efficiencies and complex interdependence of stakeholders, there is currently no notable driver for heat suppliers, building developers, owners and consumers for reducing their dependence on high supply temperatures by minimizing return temperatures on the consumer side. Consequently, high temperature heating systems in existing and new buildings will be

continuously used, which creates a significant lock-in effect for further using high temperature heat sources [9]. If it is not possible to break out of this so-called “high temperature vicious circle” [10], the transition towards alternative heat sources and thus an efficient decarbonization of the DH sector will be hindered for years or decades.

1.3. State-of the art and relevant research

In [3] the cost reduction gradient (CRG) was used to describe monetary effects due to reduced return temperatures. The CRG was applied to 27 Swedish DH networks ranging from 0.04 to 0.38 $\text{€}/(\text{MWh}\cdot\text{°C})$, based on the heat sold in the overall network. The average CRG is given at 0.12 $\text{€}/(\text{MWh}\cdot\text{°C})$. Based on an energy system modeling, temperature reduction scenarios and cost savings were analyzed in Ref. [11]. Here, a CRG between 0.1 and 0.2 $\text{€}/(\text{MWh}\cdot\text{°C})$ can be derived from the stated results. In Ref. [12], the effects were studied if all DH networks in Denmark (with annual heat sales of 28.2 TWh/a) would be transformed from the so-called third to the fourth generation of DH. The reduction of average system temperatures was assumed to be 22.5 °C. The annual saving effects were estimated at 326 million Euro per year (due to uncertainties the range is between 300 and 350 million Euro per year). The CRG results at 0.514 $\text{€}/(\text{MWh}\cdot\text{°C})$ or by considering the uncertainties in the range from 0.473 to 0.552 $\text{€}/(\text{MWh}\cdot\text{°C})$. The influence of low temperature subnetworks on a higher-level conventional DH network was analyzed in Ref. [13]. Using parameter variations, different penetration rates of the low-temperature subnetworks were simulated. On the one hand, savings due to lower heat distribution losses as well as reduced pumping demand occur, and on the other hand, higher capacity effects in CHP and flue gas condensation plants were evaluated. Depending on the penetration rate, CRGs between 0.08 and 0.26 $\text{€}/(\text{MWh}\cdot\text{°C})$ were evaluated. In Ref. [14] the DH networks temperature influence for solar thermal energy DH networks in Sweden was investigated. It was assumed that the average collector temperature could be reduced from 73 to 40 °C. The temperature reduction increases the collector yield from 379 to 627 $\text{kWh}/(\text{m}^2\cdot\text{a})$. The absolute cost reduction is evaluated to be 17.3 $\text{€}/\text{MWh}$ or 40%. The CRG is estimated at 0.64 $\text{€}/(\text{MWh}\cdot\text{°C})$. An important and comparable work was recently presented in Ref. [15]. Here, the cost reduction gradient resulting from temperature reductions in DH networks ranges between 0.07

and 0.74 €/MWh·°C). High sensitivities have been identified for geothermal, industrial waste heat, heat pumps and solar thermal. Estimations in Ref. [16] show up monetary effects in the range from 0.25 to 0.8 €/MWh·°C for different technologies and district heating network configurations.

1.4. Research contribution

In order to increase system resilience and to achieve a security of supply, there is a need for increasing the efficiency of the entire supply chain. In recent years, the Smart Energy Systems research was focusing on a fully renewable based energy system being a fuel efficient and cost-effective solution [12,17–19]. A major lever in this context is the reduction of system temperatures. However, there has been only little research on the monetary benefits of low system temperatures. Therefore, this paper is providing a contribution to push Smart Energy Systems through addressing monetary benefits.

Although there is a general understanding in the DH community of the importance of low system temperatures, there is a lack of evidence-based knowledge to evaluate the effects economically. The energy-economic assessments carried out in this paper aim at i) demonstrating the benefits of reduced system temperatures on DH networks on a technology level and ii) presenting them in a simple and comprehensible form for stakeholders. This knowledge should contribute towards breaking the previously mentioned “high temperature vicious circle” [10] for a transition into a continuous improvement process for efficient and future-proof DH networks. One of the underlying motivation is to establish a link between possible successes in temperature reductions in the system itself and the possibility to create incentives to finance and promote them [20]. This should motivate to integrate more alternative heat sources into DH networks. Where and which measures with a certain temperature reduction potential should or can be taken is out of the scope of this paper.

Compared to other research work in this area, this paper performs analyses on technology level and not on a system level. Thus, the specific effects can be addressed and understood without having to understand interactions in the complexity of a system. As the results are technology-based, they are not only applicable to DH systems but also to industrial plants. Therefore, the indicators are broader in scope and the results can be used across sectors. Beyond the key indicator “cost reduction gradient (CRG)”, this contribution also lists capacity gains due to reduced system temperatures, which have not been addressed in previous work. In addition to a broad range of generation technologies, aspects on the network itself and storage are also covered.

2. Method

The method applied follows a three-stage approach (see Fig. 1), using 1) thermodynamic models, 2) cost data and structures of technologies and 3) energy-economic assessments. The described method below is addressing the following questions:

- What is the energy-related effect of reduced system temperatures in DH networks, considering specific technologies?
- What is the economic benefit of reduced system temperatures considering the energy-related effects?
- What are relevant key indicators?

2.1. Modeling of the thermodynamic behavior

Thermodynamic models for each technology have been created to investigate temperature related behaviors. Here, technology specific models have been used which are outlined briefly in the following sections and described in detail in Ref. [21]. For *solar thermal*, an hour-based simulation was performed considering weather datasets of Vienna from Ref. [22]. The collector-specific parameters were taken from the manufacturer’s data (see Refs. [23,24]). The *heat pump* model is using the Carnot efficiency approach to estimate the COP based on the temperature levels (source, sink) (see Ref. [7]). For *CHP*, a water-steam cycle model was used. A model for combustion calculation based on elemental analysis of fuels was used for the evaluation of *flue gas condensation* (see Ref. [25]). To assess the effects of reduced system temperatures on a *DH network*, a static network calculation model was used (see Refs. [26–29]). For *geothermal*, *waste heat* and *storages* a simple capacity model was used. In all models, the thermodynamically properties according to the International Association for the Properties of Water and Steam (IAPWS) [30] are considered. The technology-specific models were parameterized (e.g. sizes, efficiencies) using reference plants. Through simulation studies in temperature variations, capacity and efficiency effects resulting from reduced temperature levels were observed. Here, the capacity gains in %/°C were derived, describing the increasing heat supply capacity of a certain heat supply technology due to lower temperatures.

2.2. Technology specific cost data

Technology cost data were researched from literature, reference plants and indicative cost estimations from manufacturer data. The cost data includes CAPEX as the cost of delivery of a plant as if no interest was incurred during construction (overnight costs) and

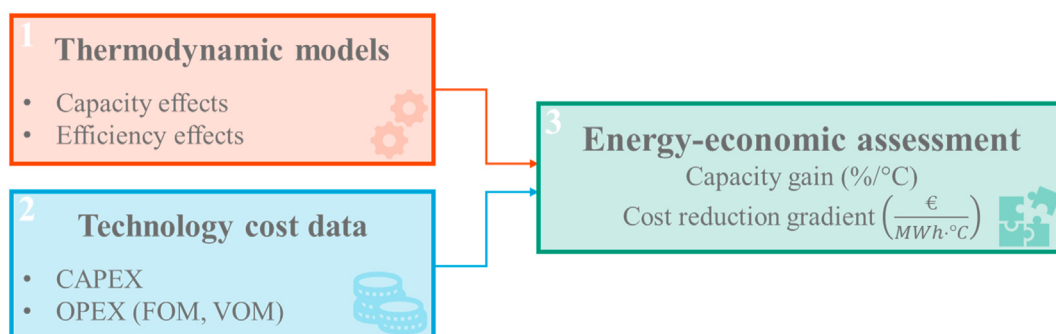

Fig. 1. Method overview for the energy-economic assessments.

OPEX results from the ongoing costs to run a plant. The operational costs are divided into the two categories: Fixed operational and maintenance costs (FOM) including periodic services and variable operation and maintenance costs (VOM) which are energy generation related costs. Furthermore, additional fuel costs may appear if applicable. Table 2 in the Annex provides an overview of underlying cost structures.

2.3. Energy-economic assessments

Based on the energy generation and cost data for each technology, energy-economic assessments have been performed to derive the key indicator cost reduction gradient (CRG). This was done comparing always two scenarios: a reference case (⊙) which can be stated as the “status quo” with the typical prevailing temperature levels (supply: 90 °C, return: 50 °C) and for an assessment case (⊗) with reduced temperatures. For each case the individual levelized cost of heat (LCOH, see Ref. [31]) per technology has been calculated according to Equation 1. The total cost reflects annuity cost in €/a and Q_{Energy} the annual heat generation in MWh/a resulting to LCOH in €/MWh. Due to reduced temperature levels in ⊗, energy-related effects leading to higher Q_{Energy} , as indicated before. As the total cost remains the same and $Q_{\text{Energy}⊗}$ increases, LCOH_⊗ decreases. The difference between higher LCOH in the reference case and lower LCOH in the assessment case can also be called “opportunity costs”.¹ In this paper the label “LCOH_{Benefit}” (see Equation 2) is used as demonstrated in Fig. 2, as lower temperatures are beneficial to LCOH. The LCOH_{Benefit} is placed in relation to the temperature reduction (see Equation 3). The result is the key indicator used in this paper: the temperature specific LCOH_{Benefit} which is defined as cost reduction gradient (CRG) in €//(MWh·°C) (see Figs. 3–6).

2.4. Methodology details and technology specific assumptions

This section provides detailed information on technology level including key assumptions. Also, the temperature changes are highlighted in the provided figures. To keep a better overview of the assumptions, the temperature changes and the associated effects, the results on the key indicators CRG and capacity gain are given in the respective figures. A summary is provided in Table 1 in section 3. Results. An overview of the most important assumptions of the plant capacities and economic data for the energy-economic assessments is given in Table 2 in the Annex.

2.4.1. Solar thermal

The temperature influence on the solar collector performance was investigated for the three collector types: i) Flat plate collector (FPC), ii) High-performance flat plate collector (Hp-FPC) and iii) Evacuated tube collector with compound parabolic concentrators (ETC-CPC). Annual collector efficiencies and collector yields were determined as a function of temperature difference ($T_m - T_a$) performing an annual simulation on an hourly basis. The reference site is Vienna with a specific horizontal irradiance of 1189 kWh/(m²·a) and an average outdoor air temperature of 11.3 °C [22]). The specific irradiation on the collector level is calculated to 1399 kWh/(m²·a)

¹ Opportunity costs represent lost revenues or benefits compared to an unrealized alternative action or optimization. The unrealized alternative or optimization corresponds to the evaluation of the generation costs at reduced temperatures. In turn, by abandoning the possibility to reduce temperatures in the system, costs arise in the reference case due to lost profits as a result of lower capacities or efficiencies. Therefore, opportunity costs are also called alternative or waiver costs. Despite this designation, opportunity costs do not represent actual costs. The avoidance of opportunity costs follows from the principle of profitability.

with an orientation to the south (azimuth of 0°) and a collector inclination of 30°.

If the mean temperature difference ($T_m - T_a$) is reduced from 70 (⊙) to 50 °C (⊗), the collector yield increases by 2.0 (FPC), 1.6 (Hp-FPC) and 0.4%/°C (ETC-CPC). FPC shows the strongest temperature dependence. The CRG is calculated at 0.67 (FPC), 0.54 (Hp-FPC) and 0.23 €//(MWh·°C) (ETC-CPC). For FPC, the CRG is higher by a factor of 3 compared to ETC-CPC. The achievable collector yield increase for the FPC is 40% (2.0%/°C * 20 °C) higher due to lower operating temperatures.

2.4.2. Geothermal

A direct use of the thermal water for heating purposes was considered for geothermal. There is no generation of electricity. The geothermal plant Ried im Innkreis (Austria) with an installed geothermal capacity of 15 MW_{th} (41.8 GWh production in 2018) [32] was used as reference for the model. It was assumed that the DH return temperature will be reduced by 5 °C in the assessment case (⊗). By increasing the temperature spread a better utilization of the thermal water is achieved and thus a capacity increase to 16.9 MW_{th} ($\hat{=}$ 47 GWh at same operating hours). Compared to the reference case (⊙) this means a capacity increase of 2.5%/°C. This is in line with analyses for the geothermal plant in Riem (Germany) [33]. The CRG is calculated at 0.67 €//(MWh·°C).

2.4.3. Heat pump

The efficiency of heat pumps (HP) depends strongly on the application and configuration (refrigerant, compressor, etc.) [7]. For simplification reasons, in the model the COP is calculated based on the temperature levels (sink and source) from the Carnot efficiency and the 2nd law efficiency of the HP. Investigations indicate the range of achievable 2nd law efficiencies between 0.4 and 0.6 [34]. For the COP calculation, an efficiency of 0.5 is used, as measurement data from various HPs on the test bench of a certifying organization confirm this value [35]. For the assessments a HP with a maximum capacity of 1 MW_{th} (8 GWh/a at 8000 operating hours per year) is used in ⊙. At an assumed source temperature of 50 °C and a sink temperature of 90 °C, the COP is calculated as 4.54. By reducing the sink temperature to 80 °C, the COP increases to 5.89. With a constant heat generation of 8 GWh/a, the electrical energy input can be reduced from 1.76 (⊙) to 1.34 GWh/a (⊗). This corresponds to a reduction in power consumption of 2.3%/°C. The electricity cost is assumed at 120 €/MWh according to Ref. [36]. By reducing the electricity costs for operating the HP, the CRG is calculated at 0.60 €//(MWh·°C).

2.4.4. Waste heat

It is assumed that waste heat is available as a water stream which is fed into a DH network. The supply temperature is 90 °C and the return temperature 50 °C. For the reference case, average values of the documented Austrian projects regarding waste heat integration in DH networks are used. The average feed-in is 43 GWh/a and the average capacity is 14.2 MW_{th} at 3031 full load hours per year [37]. By lowering the return temperature by 5 °C in ⊗, the capacity is increased while the supply temperature remains the same. Here, the amount of extracted waste heat that can be increased to 48.4 GWh/a, considering constant full load hours. Compared to ⊙, this means a capacity gain of 2.5%/°C, whereby the CRG is calculated at 0.58 €//(MWh·°C).

2.4.5. Combined heat and power

The supply temperature of a DH network is decisive for the attainable condenser pressures in CHP plants. This has a direct effect on the achievable turbine output and thus on the efficiency of the steam power process, especially in plants with back-pressure

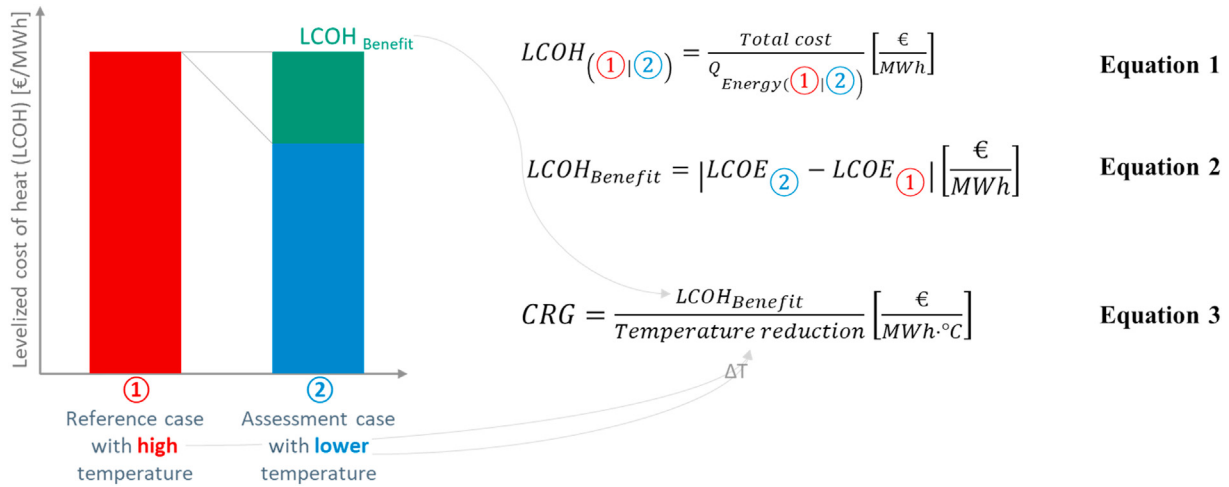

Fig. 2. Concept of the energy-economic assessments leading to the main key indicator cost reduction gradient (CRG) in €/ (MWh · °C) to describe monetary effects of reduced system temperatures in DH networks.

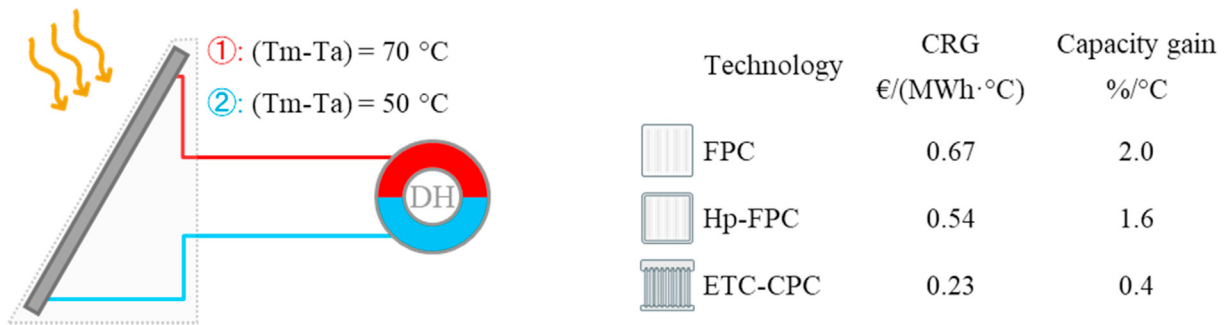

Fig. 3. Solar thermal: Scheme with changed temperature levels and key indicators due to higher solar yield for three collector types.

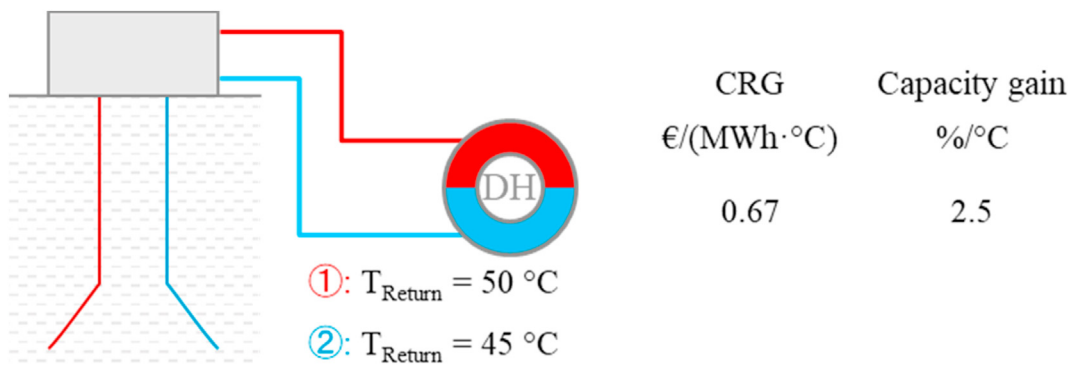

Fig. 4. Geothermal: Scheme with changed temperature levels and key indicators due to capacity gain for the direct use of geothermal energy.

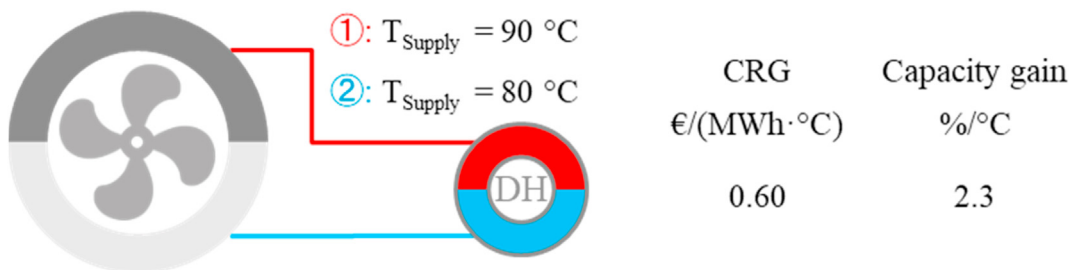

Fig. 5. Heat pump: Scheme with changed temperature levels and key indicators due to lower electrical energy input.

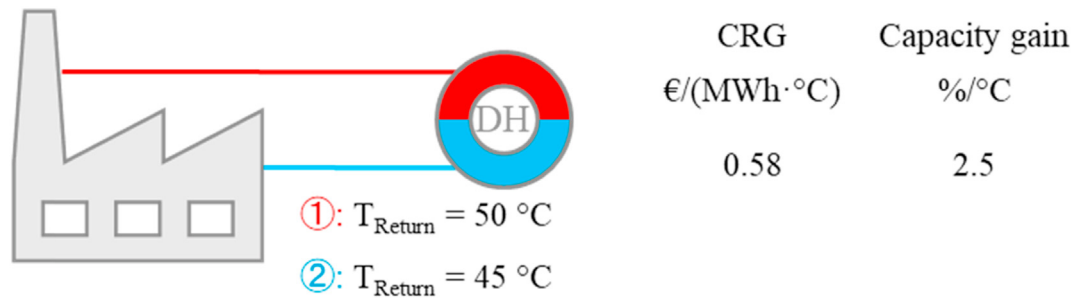

Fig. 6. Waste heat: Scheme with changed temperature levels and key indicators due to increased capacity with direct use of waste heat.

Table 1

Results from the energy-economic assessment of the investigated technologies for the cost reduction gradient (CRG) in €/MWh·°C and the potential capacity gain in %/°C.

Symbol	Technology	CRG €/MWh·°C	Capacity gain %/°C
	Flat plate collector (FPC)	0.67	2.0
	High performance FPC	0.54	1.6
	Evacuated tube collector with compound parabolic concentrators (ETC-CPC)	0.23	0.4
	Geothermal	0.67	2.5
	Heat pump ^a	0.60	2.3
	Waste heat	0.58	2.5
	Biomass-CHP with back-pressure turbine ^b	0.09	0.53
	Biomass-CHP with extraction-condensing turbine ^b	0.08	0.25
	Flue gas condensation (biomass plant)	0.10	0.8
	DH Network (increased capacity)	0.55	2.5
	DH Network (reduced mass flow)	0.11	–
	DH Network (reduced system temperature)	0.07	–
	Tank thermal energy storage (TTES) ^c	5.44	2.5
	TTES as short-term (buffer) storage ^d	0.0544	2.5
	Pit thermal energy storage (PTES) ^c	2.33	2.5
	Borehole thermal energy storage (BTES) ^c	2.25	2.5
	Aquifer thermal energy storage (ATES) ^{c, e}	2.96	5.0

^a Related to reduced drive power ($\hat{=}$ lower electricity consumption).

^b The heat output remains constant. LCOH is reduced because higher electricity output and thus higher revenues can be achieved.

^c Related to seasonal storage with one cycle per year (one full charging and discharging).

^d Related to a short-term (buffer) storage with 100 cycles per year.

^e The maximum temperatures and the usable temperature difference is lower for ATES. Therefore, the temperature reduction has a stronger influence on the capacity increase compared to other storage types.

turbines (BPT). In the case of extraction-condensing turbine (ECT) plants, the effects are less distinctive, since the steam extraction provides a higher degree of freedom. To evaluate the effects of reduced DH supply temperatures, a CHP model for steam power processes is used for both turbine types (see Fig. 7). The model includes a steam generator with reheating, a two-pressure turbine system, regenerative feedwater preheating and a DH condenser. In the ECT model, a further turbine stage (see dotted lines in Fig. 7) is used after the DH condenser to further expand the steam and thus generate more electricity. River water cooling was assumed as the cooling method. The CHP model was validated with the two biomass CHP plants Simmering (Vienna) [38] and Timelkam (Upper Austria) [39] and the parameters for the steam power process (live steam parameters: $T = 520\text{ }^{\circ}\text{C}$, $p = 120\text{ bar}$) were chosen accordingly. The heat output to be transferred is set at 40 MW_{th} in the calculated variants. Through parameter variations, the supply temperature of the DH network was varied and the influence on the achievable turbine pressures and thus on the power generation analyzed.

The reduction of the turbine steam pressure causes a higher expansion gradient which has a positive effect on the turbine performance. For the evaluated biomass CHP with BPT, the net electrical output can be increased by $0.53\%/^{\circ}\text{C}$, which increases the net electrical efficiency by $0.34\%/^{\circ}\text{C}$. As the feed water temperature is also reduced due to the lower exhaust steam pressure, more fuel must be supplied to the steam generator to reach the live steam temperature. The thermal input of the fuel must be increased by $0.18\%/^{\circ}\text{C}$. The mass flow must also be increased by $0.06\%/^{\circ}\text{C}$ to keep the heat output constant. Comparing the higher electricity revenues with the higher fuel costs, a net annual cost reduction of $274\text{ 000}\text{€}$ results which leads to the CRG of $0.09\text{ €}/(\text{MWh}\cdot^{\circ}\text{C})$.

For the biomass CHP with ECT the effects are lower, due to the higher degree of freedom. The influence on the net electrical output is $0.25\%/^{\circ}\text{C}$ and on the net electrical efficiency by $0.13\%/^{\circ}\text{C}$. The gradients are $0.12\%/^{\circ}\text{C}$ for the fuel heat output and $0.06\%/^{\circ}\text{C}$ for the mass flow. Also, the CRG is slightly lower at $0.08\text{ €}/(\text{MWh}\cdot^{\circ}\text{C})$ as a lower net annual cost reduction of $259\text{ 000}\text{€}$ appears.

The increase in turbine output and electrical efficiency proof the positive influence of reduced DH supply temperatures on the steam power process, whereby the influence on BPT is higher than with ECT. As an example, it is assumed that at a reference DH supply temperature of $90\text{ }^{\circ}\text{C}$ both plants achieve an electrical output of 20 MW . If the DH supply temperature is reduced by $10\text{ }^{\circ}\text{C}$, BPT could generate $21.1\text{ MW}_{\text{el}}$ and ECT $20.5\text{ MW}_{\text{el}}$. This illustrates the higher temperature sensitivity of BPT.

2.4.6. Flue gas condensation (biomass heat only plant)

A biomass plant with 50 MW_{th} fuel capacity and existing flue gas condensation (FGC) is considered. For utilization of FGC, the DH return temperature is key. It is assumed that the temperature can be lowered by $10\text{ }^{\circ}\text{C}$, thus reducing the flue gas temperature from $50\text{ }^{\circ}\text{C}$ to $40\text{ }^{\circ}\text{C}$ (see Fig. 8). Wood chips (the same fuel as for biomass CHP) is assumed as fuel with a calorific value of 3.3 kWh/kg ($\hat{=}$ 12 MJ/kg) in relation to the raw material. For heat recovery in FGC, the water content of the fuel and the excess air during combustion are also decisive. The water content of the fuel is assumed to be 40% and the excess air number 1.6 . More latent heat can be recovered by the assumed further cooling of the flue gas. The capacity can thus be increased by $0.8\%/^{\circ}\text{C}$, with the CRG resulting at $0.1\text{ €}/(\text{MWh}\cdot^{\circ}\text{C})$.

2.4.7. District heating network (capacity increase or reduced pumping energy, reduced heat losses)

A DH network with an annual heat production of 5 GWh was chosen as reference. The DH network is in operation all year round

(8760 h/a) and the full operating hours for the consumers were assumed to be 2000 h/a . The supply temperature is $90\text{ }^{\circ}\text{C}$ and the return temperature $50\text{ }^{\circ}\text{C}$ (annual average each). The pipe diameter is DN100 and the route length 4 km , resulting in a linear heat density of $1.25\text{ MWh}/(\text{rm}\cdot\text{a})$. It was assumed that the return temperature is reduced to $40\text{ }^{\circ}\text{C}$ (see Fig. 9). The temperature reduction leads to an increase in temperature spread which either allows an increase in capacity at constant mass flow or for a reduced mass flow.

In case of the increased capacity, the annually transferable thermal energy can thus be increased from 5.0 to 6.2 GWh . The linear thermal density also increases by $0.3\text{ MWh}/\text{rm}$. The capacity increase, due to the higher temperature spread, is calculated at $2.5\%/^{\circ}\text{C}$ and CRG at $0.55\text{ €}/(\text{MWh}\cdot^{\circ}\text{C})$.

In case of a reduced mass flow by a higher temperature spread, the transferred thermal energy remains constant at 5.0 GWh/a . Here, the mass flow can be decreased by 20% . The reduction of the mass flow causes lower flow velocities, which reduces the required pumping effort. Pump electricity cost, assumed at $120\text{ €}/\text{MWh}$ [36] as for heat pump, are thus reduced by half compared to the reference case. The CRG is thus calculated at $0.11\text{ €}/(\text{MWh}\cdot^{\circ}\text{C})$ and is lower than the previously analyzed case.

A further option addresses heat loss. In this case it is assumed that the supply temperature is reduced to the same extent as the return temperature. The temperature spread and the mass flow remain constant, thus the transferred thermal energy remains constant. A reduction of the system temperatures results in lower heat losses, since the temperature spread to the ambient temperature is reduced. The heat losses are reduced from 18% to 15% . The reduced heat losses require a lower energy input from heat generators, resulting in a CRG at $0.07\text{ €}/(\text{MWh}\cdot^{\circ}\text{C})$.

2.4.8. Storage

Using a simple capacity model, the capacity changes due to an increased temperature spread by $5\text{ }^{\circ}\text{C}$ for four storage types are investigated. The values given refer to seasonal storage with one cycle per year (i.e. one full charging and one full discharging).

For tank thermal energy storage (TTES), an upper temperature of $90\text{ }^{\circ}\text{C}$ and a lower temperature of $50\text{ }^{\circ}\text{C}$ is assumed. A higher temperature spread increases the useable storage capacity by $2.5\%/^{\circ}\text{C}$, resulting in CRG at $5.44\text{ €}/(\text{MWh}\cdot^{\circ}\text{C})$. If this storage type is used as conventional (buffer)storage, the number of cycles would be higher. If this are 100 cycles per year, this would have a proportional effect on the opportunity cost, resulting in a CRG at $0.0544\text{ €}/(\text{MWh}\cdot^{\circ}\text{C})$. This underscores the importance of high cycles in (seasonal) storage to reduce costs and is consistent with findings from Ref. [40].

For the pit thermal energy storage (PTES), the same temperature assumptions are used as for the TTES, resulting in the same capacity increase of $2.5\%/^{\circ}\text{C}$. However, the lower cost structure of this storage type leads to lower CRG at $2.33\text{ €}/(\text{MWh}\cdot^{\circ}\text{C})$.

The capacity increase for borehole thermal energy storage (BTES) is equivalent to that of TTES and PTES. Due to lower specific costs, CRG is also lower at $2.25\text{ €}/(\text{MWh}\cdot^{\circ}\text{C})$.

For aquifer thermal energy storage (ATES), the maximum temperature is limited to approx. $50\text{ }^{\circ}\text{C}$ by restrictions of the water-bearing layers [41]. For the assessment, the upper storage temperature was therefore assumed to be $50\text{ }^{\circ}\text{C}$ and the lower temperature $30\text{ }^{\circ}\text{C}$. Since the initial temperatures and also the useable temperature difference is lower, an increase in the temperature spread of $5\text{ }^{\circ}\text{C}$ has a stronger influence on the capacity increase compared to the other storage types investigated. The capacity increase is calculated at $5.0\%/^{\circ}\text{C}$ and CRG at $2.96\text{ €}/(\text{MWh}\cdot^{\circ}\text{C})$.

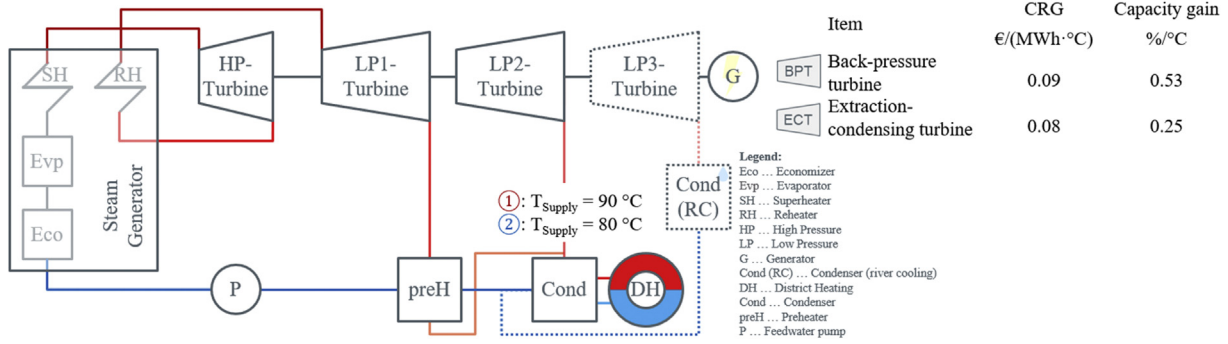

Fig. 7. CHP: Scheme with changed temperature levels and key indicators due to increased power generation.

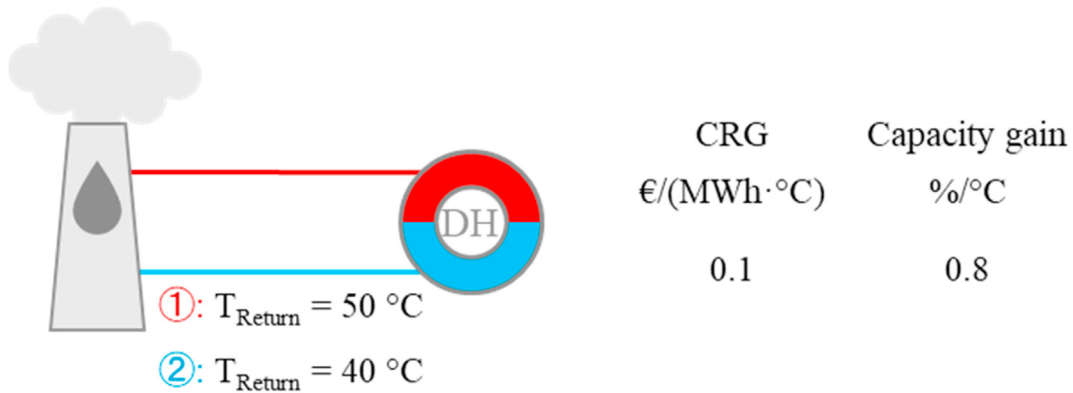

Fig. 8. Flue gas condensation: Scheme with changed temperature levels and key indicators due to capacity gain.

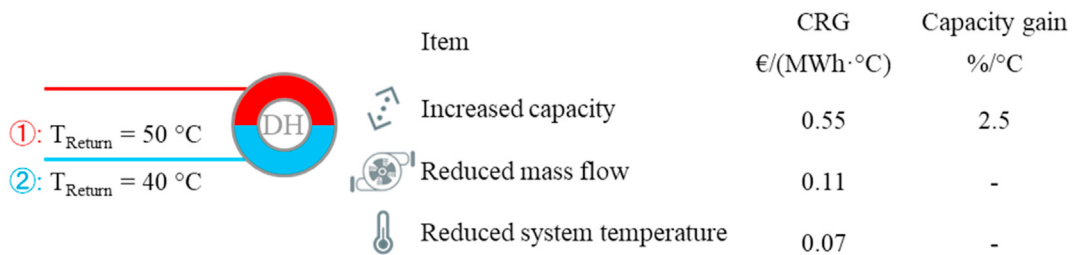

Fig. 9. DH network: Scheme with changed temperature levels and key indicators due to three different investigations.

3. Results

A total of 14 DH technologies were analyzed including nine generation technologies, the DH network itself and four types of storage. Through parameter variations, the effects of reduced system temperatures per technology were assessed and analyzed. The results of the energy-economic assessments are summarized in Table 1 using the two key indicators cost reduction gradient (CRG) and the capacity gain. The first one describes the economic benefit and the latter is the increase in capacity in %/°C at lower temperature levels or enlarged temperature spreads. The obtained effects through temperature reductions as well as key assumptions are explained on a technology level. The structure in Table 1 is based on generation technologies, followed by DH network and storage technologies. The values refer to Austrian DH networks, generation technologies, and economic data. Additional information and an overview about investigated sizes and cost data are summarized in Table 2 in the Annex.

The highest CRG for heat supply technologies results at 0.67 €/ (MWh · °C) for the flat plate solar thermal collectors with single glazing and geothermal energy (only heating purposes). The other two types of solar collectors have a lower temperature dependency, which means that the CRG also has lower values. The heat pump technology has also a high temperature dependence with a CRG at 0.60 €/ (MWh · °C). The effects here refer to higher achievable COPs and thus reduced power consumption (≙ driving energy). With a CRG at 0.58 €/ (MWh · °C), waste heat has a similar order of magnitude as heat pumps. For the CHP technology, the benefits of reduced system temperatures apply to increased power generation. Reduced inlet temperatures allow for lower exhaust steam pressures in the turbine condensers, which increases the electricity yield. A change in the supply temperature in the back-pressure turbine has a little higher effect on the CRG at 0.09 €/ (MWh · °C) compared to the CRG at 0.08 €/ (MWh · °C) for the extraction-condensing turbine. This is due to the higher degree of freedom of the extraction-condensing turbine. To enable flue gas

condensation, low return temperatures are crucial. The CRG at 0.1 €/MWh·°C) is the lowest in the comparison of heat only generation technologies. As high output and efficiency increases can be achieved by flue gas condensation, this technology should be used in all combustion processes.

With reduced return temperatures and constant supply temperatures, the transmission capacities in DH networks can be increased. Due to the increased transmission capacity, the CRG is calculated at 0.55 €/MWh·°C). The condition for this is that the corresponding heat demand is given. Alternatively, the capacity could be maintained and instead the mass flow ($\hat{\Delta}$ pumping costs) could be reduced. In this case the CRG is 0.11 €/MWh·°C). If the supply temperature would be lowered to the same extent as the return temperature (transmission capacity remains constant), the CRG is calculated at 0.07 €/MWh·°C) due to lower heat losses.

The assessment of heat storages refers to seasonal storage with a cycle number of one per year. The low number of cycles also results in high CRGs at 2.25 to 5.44 €/MWh·°C). If the tank storage (TTES) were to be operated as a short-term (buffer) storage with 100 cycles per year, this would have a proportional effect on the CRG at 0.0544 €/MWh·°C). This underlines the importance of high cycles in storage systems for cost depression.

4. Discussion

The present paper was designed to provide evidence-based data to evaluate effects of reduced district heating system temperatures in monetary terms. The added value of using the key indicators cost reduction gradient (CRG) and capacity gain for estimating the benefits of low-temperature systems, based on energy-economic assessments, is to increase motivation and conviction in such systems by various stakeholders through providing easily accessible evidence. The quantification in monetary terms can support the design of incentives towards the implementation of measures for reducing system temperatures. These can be e.g. innovative tariff, business and financing models that generate win-win situations for the stakeholders. The design of such incentive-oriented models will be the subject of further research, which can be based on the results of this study. Approaches can be found in Refs. [20,42–44].

Based on these results, stakeholders such as DH network operators, but also investors and political decision makers can consider instruments to convert these costs from unused options into opportunities and thus revenues. For example, these instruments could be used to finance or subsidize measures that enable a long-term and sustainable reduction of system temperatures. Based on these estimates, business decisions can be made on the investment in different measures, and recommendations for action can be derived and prioritized. This should enable an accelerated transformation towards low-temperature networks and thus a rapid decarbonization of the DH sector. Further on, it is important to show the benefits of reduced system temperatures in DH networks to policy makers on a regional and national scale.

The comparison with previous work shows that the examined CRGs are in similar orders of magnitude. This strengthens the evidence for monetary effects of reduced system temperatures. The capacity effects are described by thermodynamic behavior models and are considered robust. In contrast, the monetary effects are highly dependent on the underlying cost data and possibly energy prices. Therefore Table 2 in the Annex provides an overview of assumed cost structures.

Since the evaluation has been done on the individual technologies, future research should include the optimization of heat supply portfolios considering low (er) system temperatures. This is including the consideration of time resolved profiles, since the current investigation was using average values, except for solar

thermal. Further investigations may also be extended to technologies with (so far) low DH market penetration like the rotation HP [45,46]. Especially for HPs the level of detail could be increased, as they show high growth rates in DH networks. For modeling reasons, a simplified approach based on the Carnot efficiency was used in this paper. Here, further investigations with suitable models for different refrigerants and compressor types could be carried out. In the case of solar thermal energy, simulations could be performed for different locations, since both irradiation and ambient temperatures are crucial for solar yields.

5. Conclusion

This paper has explained the central importance of low (er) system temperatures in DH systems and its monetary benefits through energy-economic assessments. Both existing generation technologies such as CHP plants but also new and promising ones such as heat pumps or geothermal sources, as well as the DH network itself, were investigated. Seasonal storages were also considered, as these are increasingly being considered for future heat supply concepts. The most obvious finding from this paper is that temperature reductions will have a significantly higher impact on profitability for renewable heat generators than for the existing generation mix dominated by combustion technologies. The findings of this paper can contribute to planning and designing future/innovative heat supply concepts. As the results are technology-based, they are not only applicable to DH systems but also to industrial plants. Therefore, the indicators are broader in scope and the results can be used across sectors.

In the performed energy-economic assessments, the levelized cost of heat (LCOH) from the reference case (high temperature) and assessment case (reduced temperature) are placed in relation to the temperature reduction. This results to the key indicator which is defined in this paper as cost reduction gradient (CRG) in €/MWh·°C) and is the main contribution of assessing economic benefits on technology level. The CRG for the heat generation technologies varies from 0.08 to 0.67 €/MWh·°C). For seasonal storages, the CRG is calculated between 2.25 and 5.44 €/MWh·°C). The number of cycles is decisive for cost depression and has a proportional influence. For the DH network itself the evaluated CRG in €/MWh·°C) results at 0.55 at higher transmission capacity, 0.11 at reduced mass flow and 0.07 at reduced heat losses.

Future DH networks will be dominated by a larger portfolio of alternative heat sources. Especially for the upcoming generation technologies solar thermal, geothermal, heat pump and waste heat, a high sensitivity of the CRG depending on the temperature levels can be observed. Consequently, the system temperatures have a significantly higher influence on the economic efficiency of these technologies compared to the existing generation mix, which is currently dominated by CHP plants and heat only boilers. Therefore, measures to reduce system temperatures must be taken sooner than later to successfully transform DH networks.

Low-temperature systems can significantly contribute to the reduction of greenhouse gas emissions. For a successful implementation of low-temperature heat supply, the proof of the economic benefit is of central importance. As a result, specific policy instruments and effective funding schemes can be developed to support an accelerated transformation, in order to boost the implementation of projects with international visibility and best practices. In particular, it is important to raise awareness and sensitize political decision-makers to the need for low system temperatures and the related benefits.

In the literature, estimations on energy-economic effects based reduced system temperatures is still a niche. Hopefully, future works pick up and further develop such concepts and consider

economic benefits through reduced temperatures in their analyses. The more key indicators for the evaluation of benefits and experiences are available, the more awareness and better understanding can be established in the community, due to higher evidence.

CRedit authorship contribution statement

Roman Geyer: Conceptualization, Methodology, Formal analysis, Investigation, Data curation, Writing – original draft, Writing – review & editing, Visualization, Project administration. **Jürgen Krail:** Supervision, Writing – original draft, Writing – review & editing. **Benedikt Leitner:** Writing – original draft, Writing – review & editing. **Ralf-Roman Schmidt:** Writing – original draft, Writing – review & editing. **Paolo Leoni:** Writing – original draft, Writing – review & editing.

Declaration of competing interest

The authors declare that they have no known competing financial interests or personal relationships that could have appeared to influence the work reported in this paper.

Acknowledgements

The work presented here was carried out without any financing. The results are disseminated within the context of IEA DHC|CHP Annex TS2 "Implementation of low-temperature district heating systems" (<https://www.iea-dhc.org/home>) which is supported with funds from the Austrian Climate and Energy Fund (<https://www.klimafonds.gv.at/>).

Annex. Overview of the most important assumptions of the energy-economic assessments

Table 2
Overview of main assessed plant capacities and economic data

Technology	Assessed capacity ^a	Lifetime ^b [a]	CAPEX ^c [€]	FOM ^d [€/a]	VOM ^e [€/a]	References ^f	Total cost ^g [€/a]
Flat plate collector (FPC)	2000 m ²	20	689 454	3447	–	[35,47]	45 612
High performance FPC	2000 m ²	20	706 235	3531	–	[35,47]	46 722
Evacuated tube collector with compound parabolic concentrators (ETC-CPC)	2000 m ²	20	1 301 730	13 017	–	[35,48]	92 627
Geothermal	15 MW _{th}	25	17 203 338	375 000	–	[35]	1 256 163
Heat pump	1 MW _{th}	20	720 000	3000	14 400	[35,49,50]	272 916
Waste heat	15 MW _{th}	20	9 874 295	98 743	430 000	[37,51]	1 132 622
Biomass-CHP with back-pressure turbine	40 MW _{th} , 19.2 MW _{el}	25	52 962 548	862 5150	92 002	[35,38,52,53]	16 020 762
Biomass-CHP with extraction-condensing turbine	40 MW _{th} , 45.8 MW _{el}	25	105 693 718	2 062 575	220 008	[35,38,52,53]	33 668 582
Flue gas condensation (biomass plant)	50 MW _{th}	25	14 719 152	284 383	120 000	[35,54–56]	9 057 084
DH Network	DN100	30	1 813 000	18 130	38 883	[27,35]	133 964
Tank thermal energy storage (TTES)	10 000 m ³ _{WE}	25	2 007 038	10 035	–	[35,57]	112 837
Pit thermal energy storage (PTES)	10 000 m ³ _{WE}	25	788 963	7890	–	[35,57]	48 301
Borehole thermal energy storage (BTES)	10 000 m ³ _{WE}	25	760 930	7609	–	[35,57]	46 584
Aquifer thermal energy storage (ATES)	10 000 m ³ _{WE}	25	340 000	3400	–	[35,57]	17 001

^a Assessed capacity used for the reference case (⊙).

^b The average lifetime of the main equipment is indicated.

^c CAPEX as the cost of delivery of a plant as if no interest was incurred during construction (overnight costs).

^d Fixed operational and maintenance costs (FOM) including periodic services.

^e Variable maintenance costs (VOM) which are production-related costs depending on energy generation.

^f References are associated with the data to the left.

^g Annuitized cost which are referred here as "Total cost" (= CAPEX + OPEX).

References

- [1] Schmidt R-R, Tichler R, Amann C, Schindler I. F&E-Fahrplan Fernwärme und Fernkälte: Innovationen aus Österreich. Wien: " Klima- und Energiefonds; 2015.
- [2] Schmidt R-R, Basciotti D, Geyer R, Leoni P, Robbi S, Litzellachner A, Köfing M, Baldvinsson I, Terreros O, Maguerite C, Fazeni-Fraisl K, Goers S, Moser S, Nagler J, Ponweiser K, Schidler S, Hirschl A, Werner A, Zweiler R, Doczekal C, Frantes B, Striessnig H, Legath S, Poier H, Schubert M, Moser M. heat_portfolio. Technische Grundlagen zur signifikanten Integration dezentral vorliegender alternativer Wärmequellen in Wärmenetze. Wien: " AIT Austrian Institute of Technology GmbH; 2018.
- [3] Frederiksen S, Werner S. District heating and cooling. Lund: Studentlitteratur AB; 2013.
- [4] Werner S. International review of district heating and cooling. In: Energy, vol. 137. ELSEVIER; 2017. p. 617–31. <https://doi.org/10.1016/j.energy.2017.04.045>.
- [5] Mathiesen BV, Petersen MB, Nielsen KE, Madsen OH, Moos TM, Senger J, Strømviig J, Nielsen A, Bøgeskov HL, Schleiss U, Mirkovic S, Jensen SS, Jorsal P, Ægidius J, Dyrelund A, Ulbjerg F, Jørgensen JØ. Fernwärme und -kälte: energieeffizienz für städtische Gegenden (Weißbuch). Copenhagen: " State of Green; 2018.
- [6] Gössl M, Krutzler T, Schieder W, Schindler I, Storch A, Wiesenberger H, Goers S, Lindorfer J, de Bruyn K, Luksch C, Tichler R. Beitrag von Fernwärme, -kälte und Erdgas zu energie- und umweltpolitischen Zielen, " Umweltbundesamt GmbH im Auftrag des Fachverbands der Gas- und Wärmeversorgungsunternehmen. Wien: FGW; 2014.
- [7] Geyer R, Hangartner D, Lindahl M, Pedersen SV. Heat pumps in district heating and cooling systems," IEA heat pumping technologies Annex 47. Vienna, Lucerne, Gothenburg, Aarhus. 2019.
- [8] Totschnig G, Büchele R, Fritz S, Kranzl L, Nagler J, Ponweiser K, Baumgartner W, Postl J, Adler B, Brandmayr J, Blarke MB, Müller A. P2H-Pot: potenziale, Wirtschaftlichkeit und Systemlösungen für Power-to-Heat," TU-Wien. Wien: Institut für Energiesysteme und Elektrische Antriebe; 2018.
- [9] Köfing M, Schmidt R-R, Basciotti D, Eder K, Bogner W, Koch H, Ondra H. URBANcascade - optimierung der Energie-Kaskaden in städtischen Energiesystemen zur Maximierung der Gesamtsystemeffizienz und des Anteils erneuerbarer Energieträger und Abwärme. Wien: AIT Austrian Institute of Technology GmbH; 2016.
- [10] R.-R. Schmidt, „The DHC (r)evolution: 4 key-measures towards a future proof energy system," in 15th international Symposium on district Heating and cooling, Seoul, Republic of Korea (South Korea), september 4th - 7th 2016.
- [11] Lund R, Østergaard DS, Yang X, Mathiesen BV. Comparison of low-temperature district heating concepts in a long-term energy system perspective. In: International journal of sustainable energy planning and management, vol. 12. IJSEPM; 2017. p. 5–18. <https://doi.org/10.5278/ijsepm.2017.12.2>.
- [12] Lund H, Østergaard PA, Chang M, Werner S, Svendsen S, Sorknæs P, Thorsen JE, Hvelplund F, Mortensen BOG, Mathiesen BV, Bojesen C, Duic N, Zhang X, Möller B. The status of 4th generation district heating: research and

- results. In: *Energy*, vol. 164. ELSEVIER; 2018. p. 147–59. <https://doi.org/10.1016/j.energy.2018.08.206>.
- [13] Castro Flores JF, Lacarrière B, Chiu JN-W, Martin V. Assessing the techno-economic impact of low-temperature subnets in conventional district heating networks. In: *Energy procedia*, vol. 116. ELSEVIER; 2017. p. 206–72. <https://doi.org/10.1016/j.egypro.2017.05.073>.
- [14] Averfalk H, Werner S. Efficient heat distribution in solar district heating systems. In: 5th international solar district heating conference, graz, SDH solar district heating: proceeding; 2018. p. 63–6.
- [15] Averfalk H, Werner S. Economic benefits of fourth generation district heating. In: *Energy*, vol. 193. ELSEVIER; 2020, 116727. <https://doi.org/10.1016/j.energy.2019.116727>.
- [16] Müller A, Heimrath R, Leoni P, Schrammel H. How much to invest? Balancing investment costs and economic benefits of reducing the temperature levels in existing district heating networks. In: 6th international conference on Smart energy systems; 6-7 October 2020. <https://smartenergysystems.eu/conference-2020/>.
- [17] Mathiesen B, Lund H, Connolly D, Wenzel H, Østergaard P, Möller B, Nielsen S, Ridjan I, Karnøe P, Sperling K, Hvelplund F. Smart Energy Systems for coherent 100% renewable energy and transport solutions. In: *Applied energy*, vol. 145. ELSEVIER; 2015. p. 139–54. <https://doi.org/10.1016/j.apenergy.2015.01.075>.
- [18] Lund H, Østergaard PA, Connolly D, Mathiesen BV. „Smart energy and smart energy systems. In: *Energy*, vol. 137. ELSEVIER; 2017. p. 556–65. <https://doi.org/10.1016/j.energy.2017.05.123>.
- [19] Lund H, Duic N, Østergaard PA, Mathiesen BV. Future district heating systems and technologies: on the role of smart energy systems and 4th generation district heating. In: *Energy*, vol. 165. ELSEVIER; 2018. p. 614–9. <https://doi.org/10.1016/j.energy.2018.09.115>.
- [20] Leoni P, Geyer R, Schmidt R-R. „Developing innovative business models for reducing return temperatures in district heating systems: approach and first results. In: *Energy*, vol. 195. ELSEVIER; 2020, 116963. <https://doi.org/10.1016/j.energy.2020.116963>.
- [21] Geyer R. „Reduzierte systemtemperaturen in wärmenetzen: eine energie-ökonomische bewertung der Effekte. Pinkafeld: FH Burgenland; 2020.
- [22] Meteotest AG. „Meteonorm 7.1.11. Bern: Meteotest AG; 2016.
- [23] GREENoneTEC. Grossflächenkollektor GK3003 - serie. GREENoneTEC Solarindustrie GmbH, St. 2018. Veit an der Glan.
- [24] Ritter XL Solar. Vakuumsröhrenkollektoren baureihe XL P. Ritter Energie- und Umwelttechnik. Dettenuhausen: GmbH & Co. KG; 2017.
- [25] Kaltschmitt M, Hartmann H, Hofbauer H. *Energie aus Biomasse - Grundlagen, Techniken und Verfahren*. Heidelberg: Springer-Verlag Berlin Heidelberg; 2016.
- [26] Fernwärme QM, Verenum AG. http://www.verenum.ch/Dokumente_QMFW.html. [Accessed 8 August 2020].
- [27] Nussbaumer T, Thalman S, A. Jenni und J. Ködel, „Planungshandbuch Fernwärme,“ *EnergieSchweiz*. Bern: Bundesamt für Energie BFE; 2018.
- [28] AGFW, *Technisches Handbuch Fernwärme*. Frankfurt am Main: AGFW | Der Energieeffizienzverband für Wärme, Kälte und KWK e. V.; 2009.
- [29] Thalman S, Nussbaumer T, Jenni A. *Umsetzung Optimierungsmaßnahmen Fernwärme,“ ARGE Fernwärme – verenum und Ardens GmbH*. Zürich und Liestal; 2016.
- [30] IAPWS. The international association for the properties of water and steam. 6 April 2020. <http://www.iapws.org/>.
- [31] Kost C, Shammugam S, Jülich V, Nguyen H-T, Schlegl T. *Stromgestehungskosten erneuerbare energien*. Freiburg: Fraunhofer-Institut für Solare Energiesysteme ISE; 2018.
- [32] Goldbrunner J, Götzl G. Geothermal energy use, country update for Austria. In: *European geothermal congress 2019*. Den Haag; 11-14 June 2019.
- [33] SWM. *Fernwärme und Rücklaufemperatur in modernen Niedertemperaturnetzen*. München: „Stadtwerke München; 2015.
- [34] Arpagaus C, Bless F, Uhlmann M, Schiffmann J, Bertsch SS. High temperature heat pumps: market overview, state of the art, research status, refrigerants, and application potentials. *Energy* 2018;152. <https://doi.org/10.1016/j.energy.2018.03.166>.
- [35] Grosse R, Binder C, Wöll S, Geyer R, Robbi S. Long term (2050) projections of techno-economic performance of large-scale heating and cooling in the EU. Luxembourg: „Publications Office of the European Union; 2017.
- [36] BMNT. *Energie*. In: *Österreich Zahlen, Daten Fakten*, editors. Bundesministerium für Nachhaltigkeit und Tourismus, Wien; 2019.
- [37] Moser S. Und S. Lassacher, „External use of industrial waste heat - an analysis of existing implementations in Austria. Linz: Energy Institute at the Johannes Kepler University Linz; 2020.
- [38] Wien Energie GmbH. *Biomassekraftwerk simmering,“ wien energie GmbH*. Wien Energie Vertrieb GmbH & Co KG; 2020. <https://www.wienenergie.at/eportal3/ep/channelView.do?channelId=48494>. [Accessed 23 May 2020].
- [39] Energie AG Oberösterreich. *Biomasseanlage Timelkam*. <https://www.energieag.at/Themen/Energie-fuer-Sie/Kraftwerke/Thermische-Kraftwerke/Biomassekraftwerk-Timelkam>. [Accessed 23 May 2001].
- [40] Köfinger M, Schmidt R-R, Basciotti D, Terreros O, Baldvinsson I, Mayrhofer J, Moser S, Tichler R, Pauli H. Simulation based evaluation of large scale waste heat utilization in urban district heating networks: optimized integration and operation of a seasonal storage. In: *Energy*, vol. 159. ELSEVIER; 2018. p. 1161–74. <https://doi.org/10.1016/j.energy.2018.06.192>.
- [41] Mangold D, Miedaner O, Tziggili EP, Schmidt T, Unterberger M, Zeh B. *Technisch-wirtschaftliche Analyse und Weiterentwicklung der solaren Langzeit-Wärmespeicherung*. Stuttgart: Solites - Steinbeis Forschungsinstitut für solare und zukunftsfähige thermische Energiesysteme; 2012.
- [42] Lygnerud K. Challenges for business change in district heating. In: *Energy, sustainability and society*. Springer Nature; 2018. p. 8–20. <https://doi.org/10.1186/s13705-018-0161-4>.
- [43] Lygnerud K. Business model changes in district heating: the impact of the technology shift from the third to the fourth generation. In: *Energies*, vol. 12. MDPI; 2019. p. 1778. <https://doi.org/10.3390/en12091778>.
- [44] Lygnerud K, Wheatcroft E, Wynn H. Contracts, business models and barriers to investing in low temperature district heating projects. In: *Urban district heating and cooling technologies*, vol. 9; 2019. p. 3142. <https://doi.org/10.3390/app9153142>. 15.
- [45] Adler B, Mauthner R. „Rotation heat pump (RHP). In: 12th IEA heat pump conference, rotterdam; 2017.
- [46] ecop. *Rotation heat pump,“ ecop technologies GmbH*. 2021. <https://www.ecop.at/en/home-4/>. [Accessed 21 February 2021].
- [47] GREENoneTEC. *Richtpreisangebot Solarthermieanlage für FW-Einspeisung,“ GREENoneTEC Solarindustrie GmbH*. St. Veit an der Glan; 2020.
- [48] Ritter XL Solar. *Richtpreisangebot Solarthermieanlage für FW-Einspeisung,“ Ritter Energie- und Umwelttechnik*. Dettenuhausen: GmbH & Co. KG; 2017.
- [49] Wien Energie GmbH. *Großwärmepumpe simmering,“ wien energie GmbH*. Wien Energie Vertrieb GmbH & Co KG; 2020. <https://www.wienenergie.at/eportal3/ep/channelView.do?pageTypeld/67831/channelId/-4401482>. [Accessed 1 June 2020].
- [50] Riise-Knudsen I, Ebbenhøj SL, Paaske BL, Nissen LF, Jensen H-H, Risom J. *Store varmpumper i fjernvarmeforsyningen: evaluering af initiativerne for rejsehold og tilskudsordning for store varmpumper i fjernvarmeforsyningen*. København: Energistyrelsen; 2016.
- [51] Moser S, Tichler R, Mayrhofer J, Goers S, Baresch M, Köfinger M, Baldvinsson I, Basciotti D, Terreros O, Schmidt R-R, Pauli H, Berger G, Vetr W. *Futur-eDHSYSTEM Linz - sondierung neuer Konzepte für zukünftige Energie-Transformationen im Linzer Wärmesystem,“ Energieinstitut an der Johannes Kepler Universität Linz*. Linz AG, Linz und Wien: AIT Austrian Institute of Technology GmbH; 2017.
- [52] klima:aktiv. *Energieholz kenndatenkalkulation*. <https://www.klimaaktiv.at/erneuerbare/energieholz/werkzeuge-und-hilfsmittel/kenndatenkalkulation.html>. [Accessed 6 August 2020].
- [53] IEA-ETSAP & IRENA. *Biomass for heat and power: technology brief,“ IEA energy systems analysis programme (ETSAP) and international renewable energy agency (IRENA)*. 2015. Cork and Abu Dhabi.
- [54] DEA and Energinet. *Technology data - energy plants for electricity and district heating generation*. Copenhagen and Fredericia: Danish Energy Agency and Energinet; 2020.
- [55] De Vita A, Kielichowska I, Mandatowa P, Capros P, Dimopoulou E, Evangelopoulou S, Fotiou T, Kannavou M, Siskos P, Zazias G. *Technology pathways in decarbonisation scenarios,“ E3-Modelling and Ecofys and Tractebel*. 2018. Athens and Utrecht and Brussels.
- [56] Ikonline. *Holzmarktbericht der LK Österreich,“ Landwirtschaftskammer Österreich*. <https://www.lko.at/juli-2020-holzmarktbericht-der-lk-%C3%BCsterreich+2500+3237150>. [Accessed 6 August 2020].
- [57] Mauthner F, Herkel S. „Technology and demonstrators - technical report subtask C – Part C1: classification and benchmarking of solar thermal systems in urban environments,“ IEA SHC task 52 (solar heat and energy economics in urban environments). 2016. Gleisdorf.